

# Topology and geometry of mixing of fluids

Andrei Ludu, Stefan Mancas

Ionutz Ionescu, Audrey Gbagaudi, Matthew Schumacher,

Embry-Riddle Aeronautical University, Daytona Beach

GFS Corporation, Florida

Wärtsilä Company, Finland

**June 2012**

## Table of contents:

- Technical and scientific motivations
- Mathematical approaches for mixing two fluids
- Highly incompressible fluids (liquids) in closed and open flow
- Braided structures with positive topological entropy
- Preliminary experiments

## Conclusions

# Mixing

**Stirring** is the mechanical motion of the fluid: the cause;

**Mixing** is the homogenization of a substance: effect.



...A traditional joke is that a topologist can't distinguish a coffee mug from a doughnut.. **How about what's in your mug?**

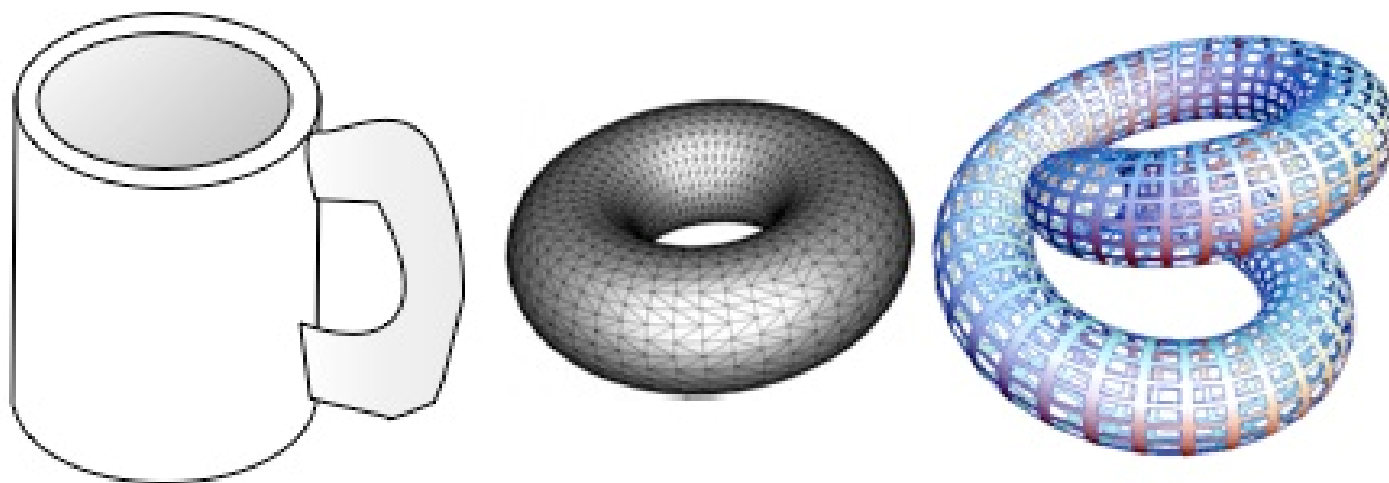

- It comes as a surprise to many that mixing is actually a proper field of study.
- After all, how much of a mathematical challenge can stirring milk in a teacup present?
- Well, quite a difficult one, actually! For the particular case of the teacup, stirring creates turbulence, and turbulent flows are usually extremely good at mixing.



Turbulence is hard—if not impossible—to understand, so we are already in dangerous territory.

JEAN-LUC THIFFEAULT and MATTHEW D. FINN,  
Topology, braids and mixing in fluids,  
Phil. Trans. R. Soc. A (2006) 364, 3251–3266

The teacup is not the best example because there is not much to achieving good mixing: a flick of the wrist will usually suffice.

But there are many other situations of practical interest where this is not the case for various reasons.

The basic setting is the same: given some quantity (e.g. milk, temperature, moisture, salt, dye, etc. usually referred to as **the scalar field** ) that is **transported by a fluid** (e.g. air or water):

How does the concentration of that substance evolve in time?

From there very different questions can arise.

1. Does the scalar concentration tend to a constant distribution
2. If so, how rapidly?
3. Does the scalar eventually fill the entire domain, or are there transport barriers that prevent this?
4. How much energy is required to stir the fluid?

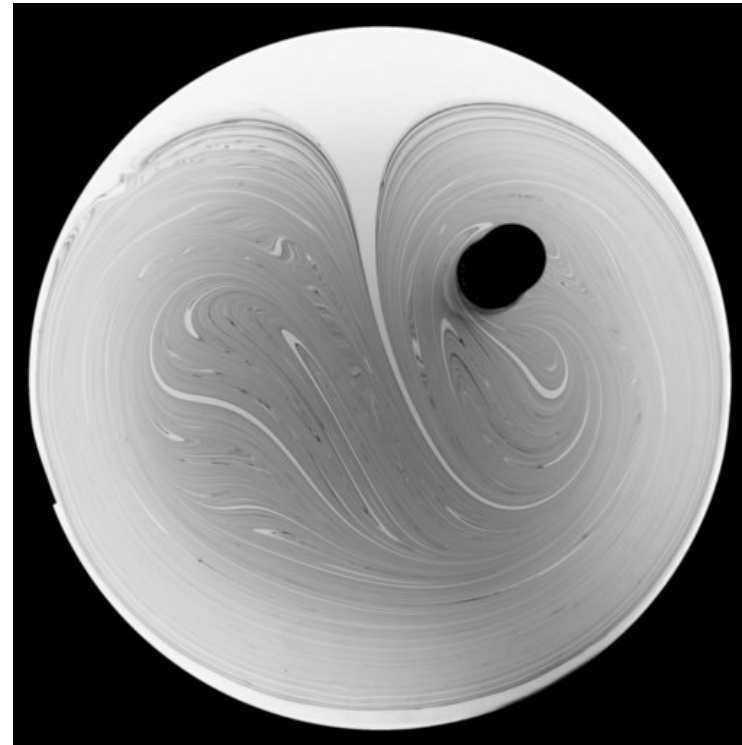

What is the mechanism that redistributes a couple of scalars in a mixing process?

One candidate is molecular diffusion, which all scalars undergo, but that is utterly negligible in practical applications.

The primary mode of redistribution is by far transport by currents. In this case, the scalars are active rather than passive.

For modeling (e.g. climate, combustion), it is crucial to know how fast the global redistribution of the scalar occurs.

- If the fluid motion takes place at micro-scales (on the surface of microchips., or in the molecular diffusion of DNA) the motion of a fluid like water behaves as a viscous fluid: turbulence is impractical to achieve.
- The problem is that the fluid motion is so regular that mixing is very difficult, and is very slow .
- This is where chaotic mixing becomes the best option, and the field has undergone a renaissance owing to lab-on-a-chip applications



Steady three-dimensional flows could have chaotic trajectories (Henon, 1966).

Two-dimensional flows with time dependence, could have chaotic trajectories, too.

The advantage of this for fluid mixing: **chaotic advection**. (Aref, 1984).

The flow pattern is not changing in time, but if one starts two particle trajectories close to each other they diverge exponentially, at a rate given by the Lyapunov exponent of the flow.

When the flow is chaotic the fluid particles rapidly become uncorrelated and forget about each other's whereabouts.

That is exactly what it means for a scalar to be mixed: the initial concentration field is forgotten, then the molecular diffusion is ultimately achieving this homogenization

Chaotic mixing can potentially achieve the same result as turbulence, but with much simpler fluid motion and at a lower energy cost.

Chaotic mixing is a process by which flow tracers develop into complex fractals under the action of a fluid flow.

The flow is characterized by an exponential growth of fluid filaments.

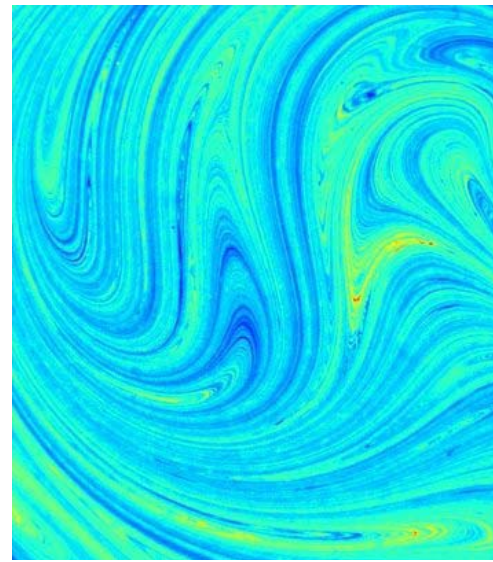
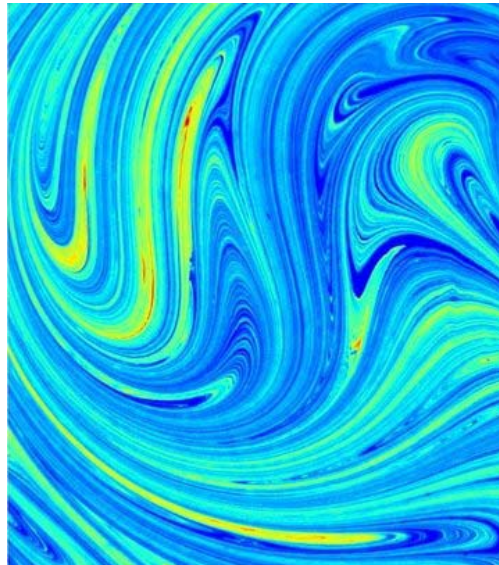
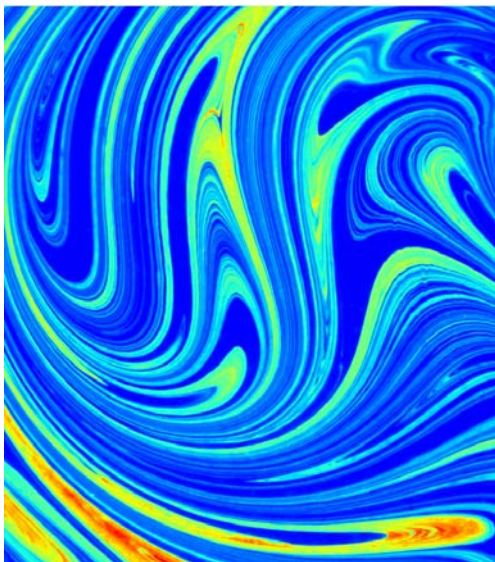

At least 3 degrees of freedom are necessary for a dynamic system to be chaotic.

Three-dimensional flows have three degrees of freedom corresponding to the three coordinates, and usually result in chaotic advection, except when the flow has symmetries that reduce the number of degrees of freedom.

In flows with less than 3 degrees of freedom, Lagrangian trajectories are confined to closed tubes, and shear-induced mixing can only proceed within these tubes.

# GTI BI-FUEL<sup>®</sup> SYSTEM



Rotation -> helical transport

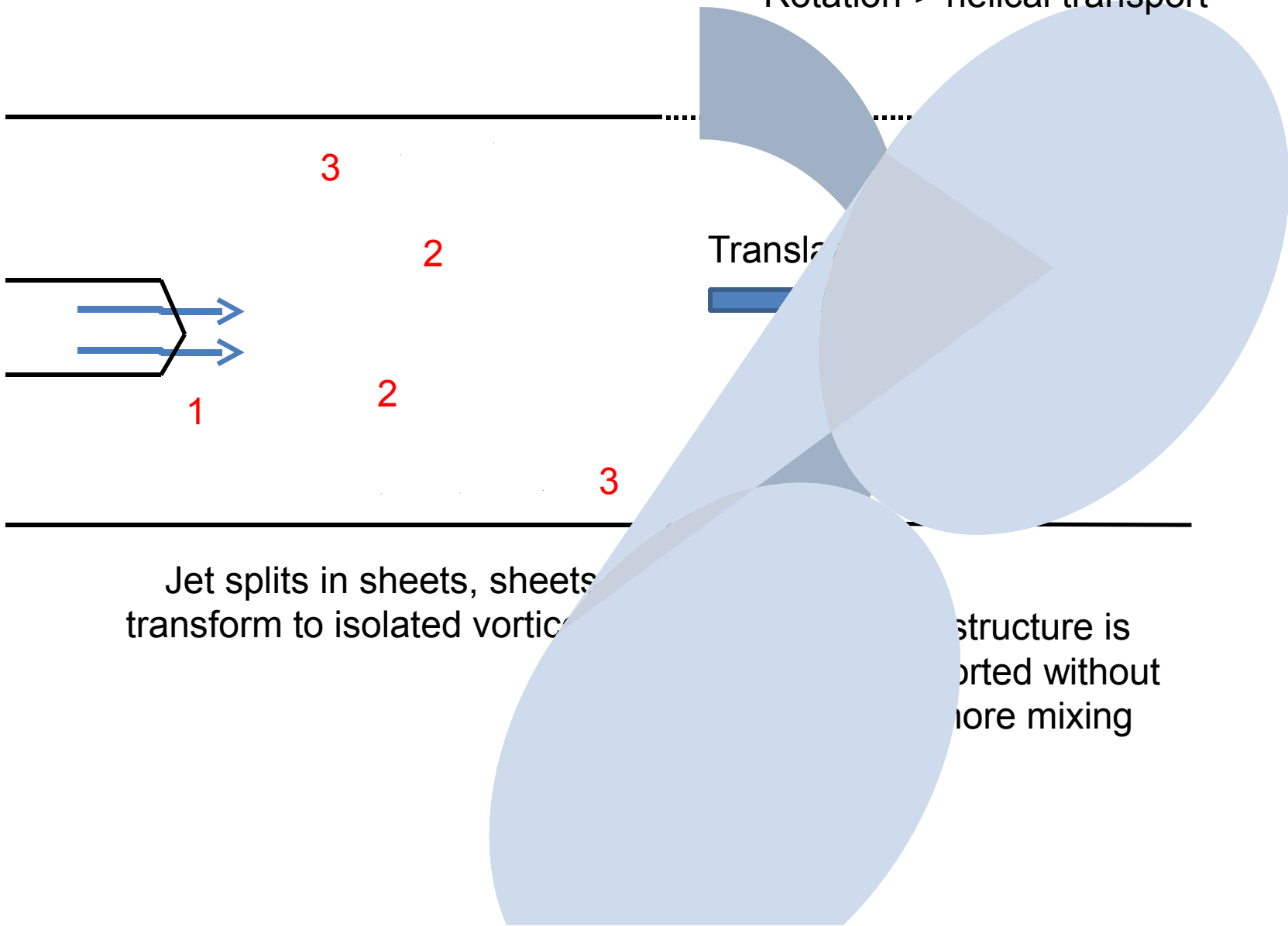

3

2

2

1

3

Translation

Jet splits in sheets, sheets transform to isolated vortices

structure is transported without more mixing

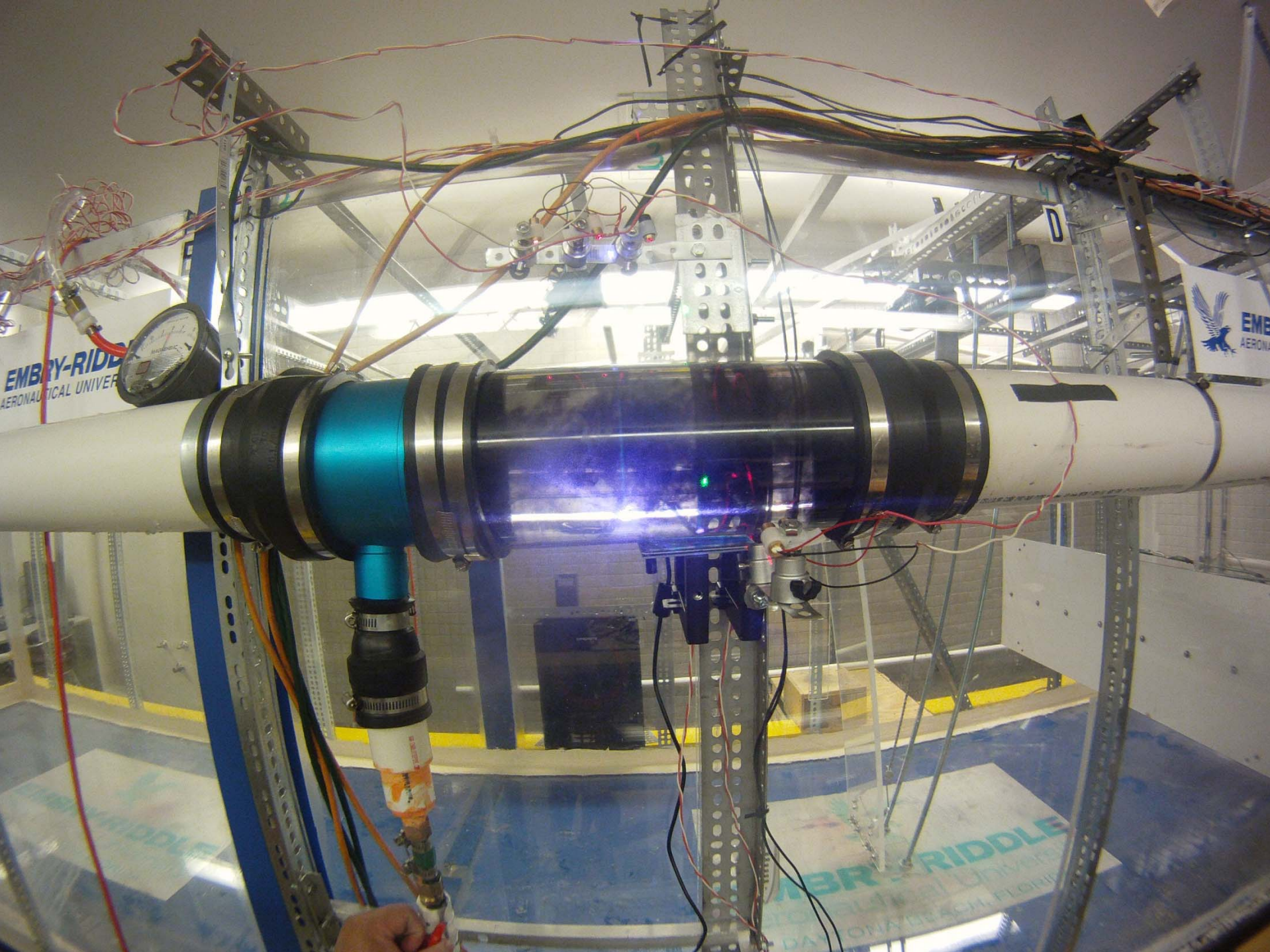

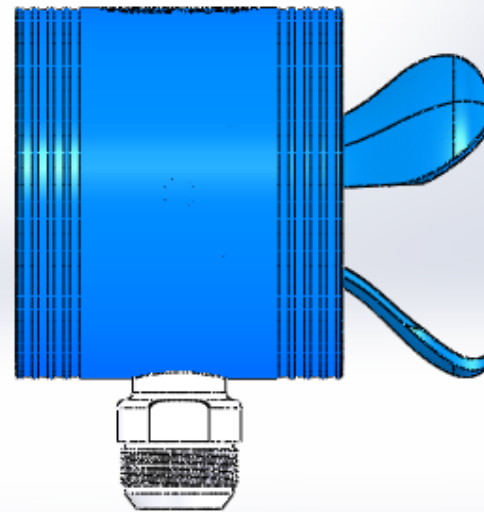
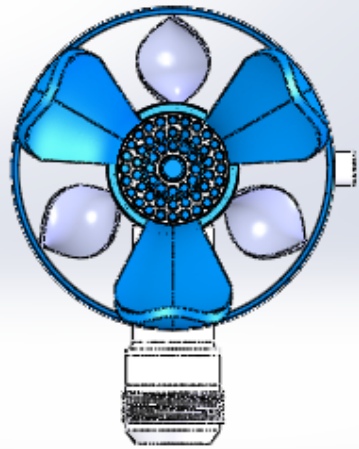

\*Left

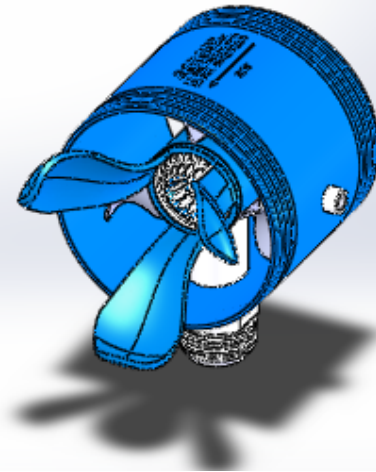
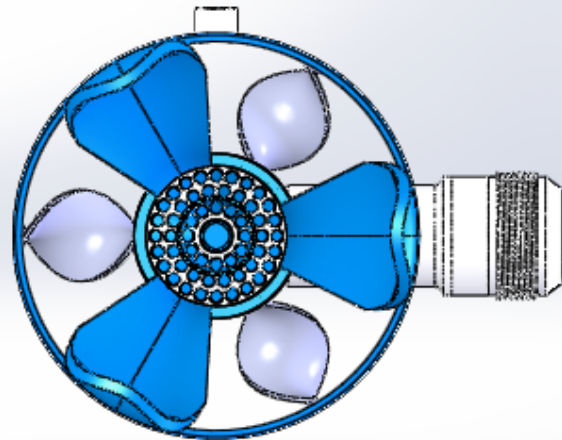



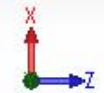
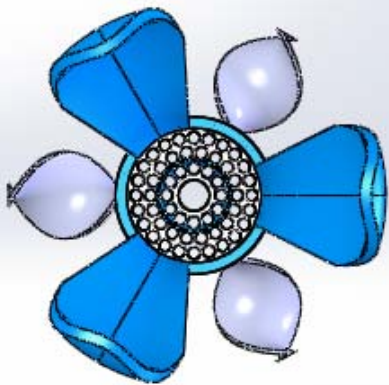
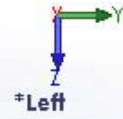
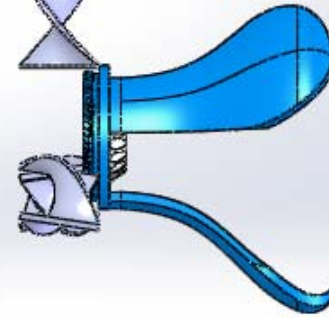
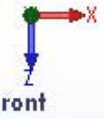

## Topological chaos methods:

Given a diffeomorphism  $f$  between two-dimensional compact manifolds, the Thurston–Nielsen classification theorem tells us that  $f$  is isotopic to  $g$  which is one of three types of mapping.

1. Finite-order. If  $g$  is repeated enough times, the resulting diffeomorphism is the identity.
2. Pseudo-Anosov (pA).  $g$  stretches the fluid elements by a factor  $x > 1$ , so that repeated application gives exponential stretching;  $x$  is called the dilatation of  $g$  and  $\log x$  is its topological entropy.
3. Reducible.  $g$  leaves a family of curves invariant, and these curves delimit sub-regions that are of type 1 or 2.

Anosov diffeomorphisms are the prototypical chaotic maps: they stretch uniformly everywhere. A pseudo-Anosov map allows for a finite number of singularities in the stable and unstable foliations of the map.

The best mixing should induce a diffeomorphism  $f$  that is either isotopic to a pseudo-Anosov map, or splits  $M$  into subregions that include type 2 components.

However, most industrial situations involve open flows: fluid enters a mixing region only for a finite time, and then exits, having hopefully been mixed.

In this case topological considerations cannot tell anything. The Thurston–Nielsen theorem does not apply,

Until one can define a topological entropy by looking at the growth rate of material lines or the density of periodic orbits, we prefer to approach the mixing from a PDE point of view.

## Present theories:

- Freidlin-Wentzell theory (2002) studies an advection-diffusion equation and, for a class of Hamiltonian flows, proves the convergence of solutions as the velocity of the fluid  $\rightarrow \infty$ .
- The conditions on the flows for which the procedure can be carried out are given in terms of certain non-degeneracy and growth assumptions on the stream function.

- Kifer, Berestycki, Hamel and Nadirashvili theory (1991). employs probabilistic methods and is focused, in particular, on the estimates of the principal eigenvalue of the advection operator'

They described the asymptotic behavior of the principal eigenvalue (which determines the asymptotic rate of decay of the solutions of the initial value problem),

...and the corresponding positive eigenfunction in the case where the diffusion operator has a discrete spectrum and sufficiently smooth eigenfunctions.

The principal eigenvalue stays bounded as  $flow \rightarrow \infty$  if and only if  $u$  has a first integral in  $H_1$

However, in the case of a compact manifold without boundary or Neumann boundary conditions the principal eigenvalue is simply zero and corresponds to the constant eigenfunction.

Instead one is interested in the speed of convergence of the solution to its average, the relaxation speed.

In studying the advection-enhanced diffusion one needs estimates on the velocity-dependent norm decay at a fixed positive time.

- In the Constantin, Kiselev, Ryzhik, Zlatos theory (2008) unitary evolution alternates with dissipation.

The absence of sufficiently regular eigenfunctions appears as a key for the lack of enhanced relaxation in this particular class of dynamical systems.

- We present here a characterization of incompressible flows that are relaxation enhancing, in a general setup.

NOTE: The study uses dynamical estimates, and do not discuss the spectral gap.

We assume that the solution tends to a certain limit and define relaxation enhancement in terms of speed up in reaching this limit.

The theoretical framework to describe the equilibrium properties of a binary fluid mixture is given by a Landau-type mean-field theory in which the free-energy:

where  $\rho$  and  $\phi$  are the total density, and the concentration difference between the 2 components, respectively.

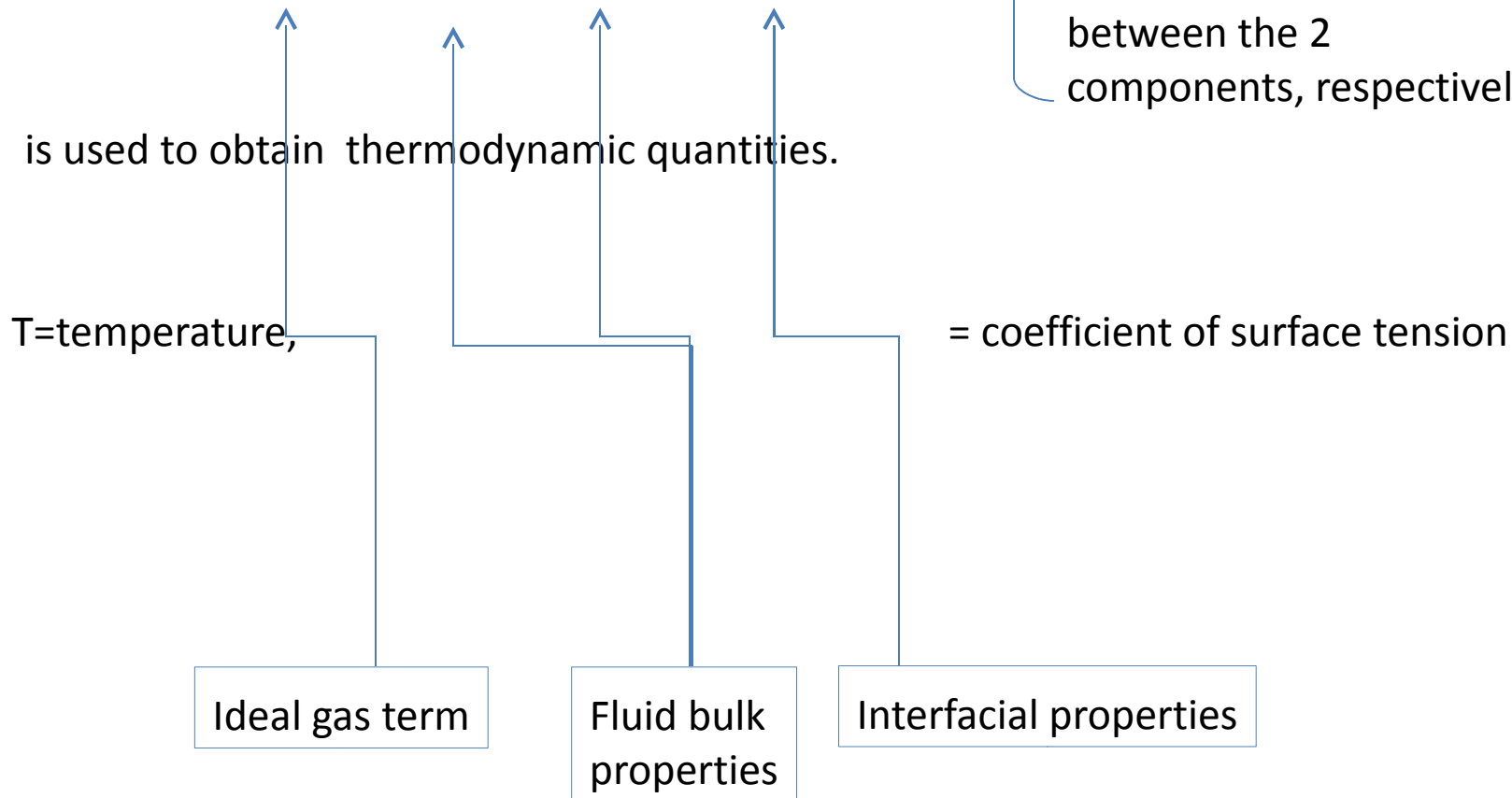



The corresponding thermodynamic quantities are:

Chemical potential

Pressure tensor

The mean-field coefficients are explained from these relations:  $a$  is related to linear properties,  $b$  is related to the nonlinear terms.

Here

the fluid velocity, the shear and bulk viscosities, mobility coeff.

The fluid flow is described by the Navier-Stokes equations:

Reynolds number

Strouhal number

(Eq. 1)

We generalize the passive scalar equation, Eq. 1 :

(Eq. 1)

Into the abstract one:

Eq. (2)

which is a Bochner type of ODE in time.

In some cases we can study with the same model an open flow mixing system.

In this case we either consider  $M$  to be non-compact, or we consider the sources of the flow, as divergence terms in the compact manifold  $M$ :

We have the homogenous Sobolev spaces

such that

associated with  $\Gamma$  formed by

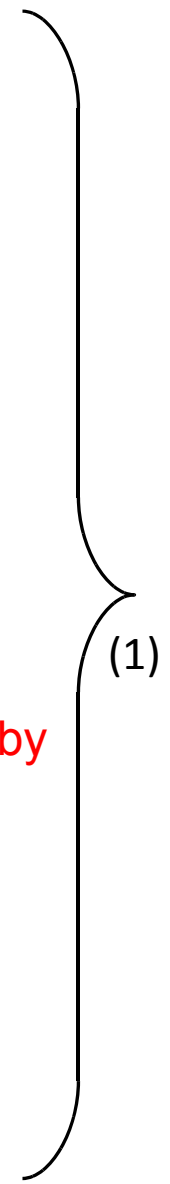

(1)

We use the following criterion to describe the incompressible flow efficiency in improving the solution relaxation, and thus enhancing the mixing process by advection.

Definition of **relaxation enhancing**:

In the following we will work on the Hilbert space  $H$  of functions with zero mean.

**Theorem 1** Constantin-Kiselev-Ryzhik-Zlatoš *Ann. Math.* 168 (2008) 643





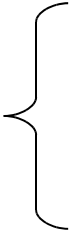

We write Eq. (1) 

In a different form:

with a rescaling of time, and



$$\frac{d}{dt} \|\Phi^\varepsilon(t)\|^2 = -2\varepsilon \|\Phi^\varepsilon\|_1^2 .$$



A function  $f$  is in  $C_c(X)$  if for every open subset  $U$

contained in  $M$  such that  $U$  is relatively compact (i.e. the closure of  $U$  is compact),

the restriction of  $f$  to  $U$  is in  $C_c(U)$ .



In order to show this we use the so called **RAGE Theorem**. (Ruelle 1969, W. O. Amrein, V. Georgescu, 1974, and W. Enss 1978)

See for example:

*H. Cycon, R. Froese, W. Kirsch and B. Simon, Schrödinger Operators (Springer-Verlag, 1987)*

The origin of this theorem lies in the observation that for the free linear Schrödinger equation all solutions are radiative or “pseudorandom” (i.e. *profile decomposition*).

A sequence of solutions to the free linear Schrödinger equation can be split into a small number of "structured" components which are localized in space-time and in frequency, plus a "pseudorandom" term which is dispersed in space-time, and is small in various useful norms.



The RAGE theorem asserts, that there are no further types of states, and that every state decomposes uniquely into a bound state and a radiating state.

RAGE theorem is also related to *Strongly mixing* systems.

For any two sets  $E$  and  $F$  in a measure-preserving system (a probability space  $X$  and a shift map  $T$  (measuring preserving, invertible and bi-measurable))

we have:

This is saying that shifted sets become asymptotically independent of un-shifted sets.





So, by using the **RAGE Theorem**, we know that if the initial data lies in the continuum spectrum of  $L$  then the  $L$ -evolution will spend most of the time in higher modes of  $\Gamma$ . That is, on one hand:

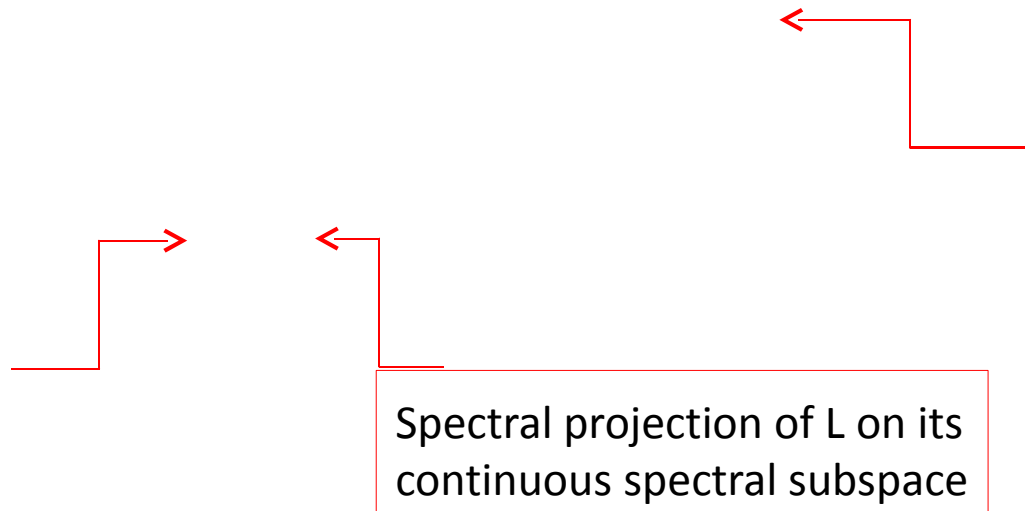



Spectral projection of  $L$  on its  
pure point spectrum subspace

Sketch of the 2nd part of the proof of **Theorem 1** based on **Lemma 2**,  
the **RAGE Theorem**, **Lemma 3** and **Property 2**



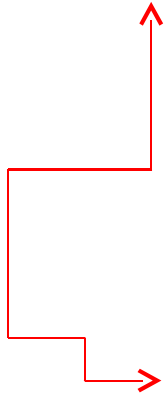

Which concludes the proof of **Theorem 1**.

Generalization for reaction-diffusion-advection equations.

It contains a nonlinear reaction term  $f$  (Boltzmann equation)

We have:



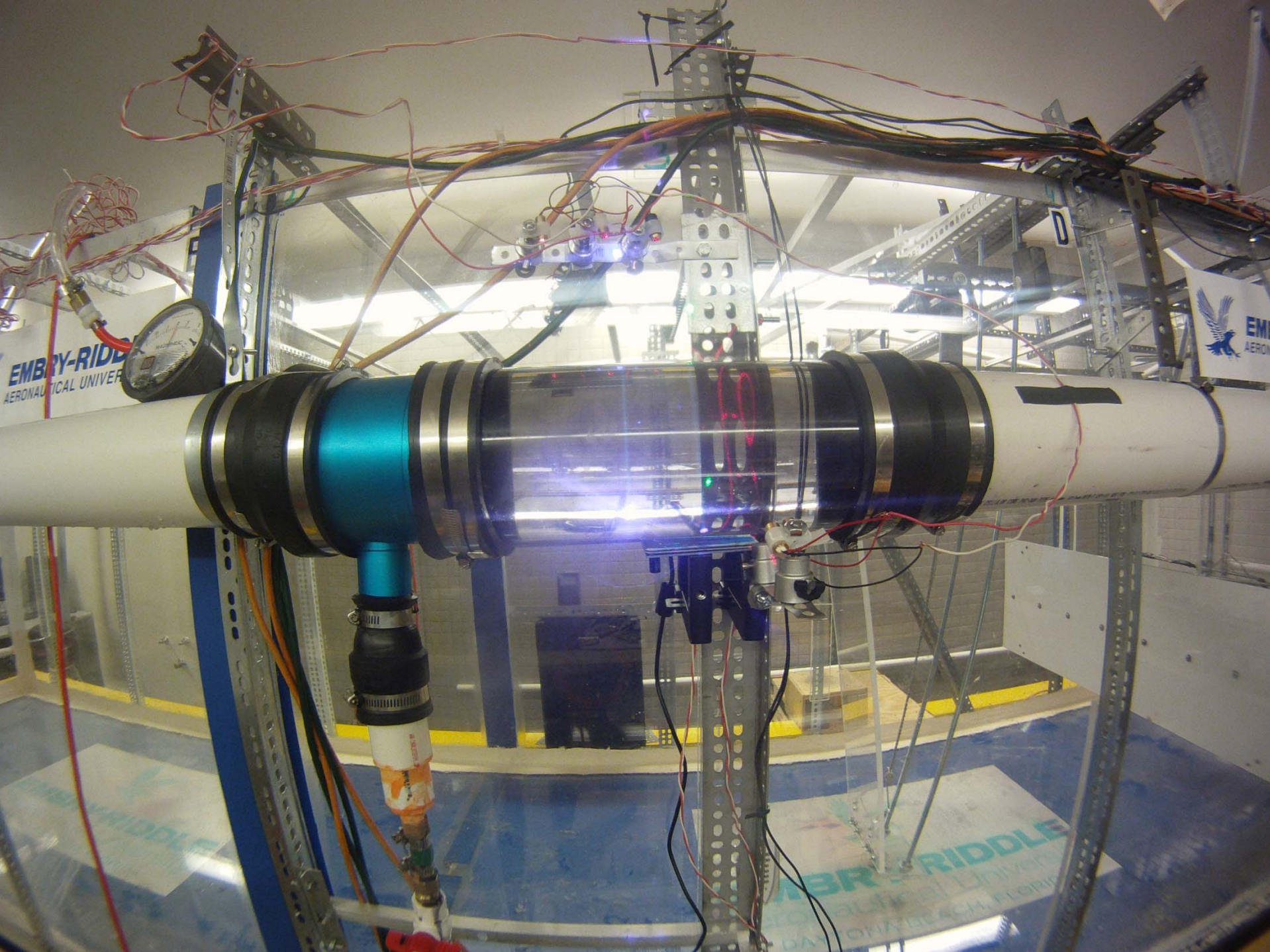

# NLWL 2

- 2,200 gallons water max.
- 15.5 feet long
- 4 waves generator
- Electromagnetic, Interferometry
- Pneumatic earthquake simulator

# The construction

September



July





October-November





November

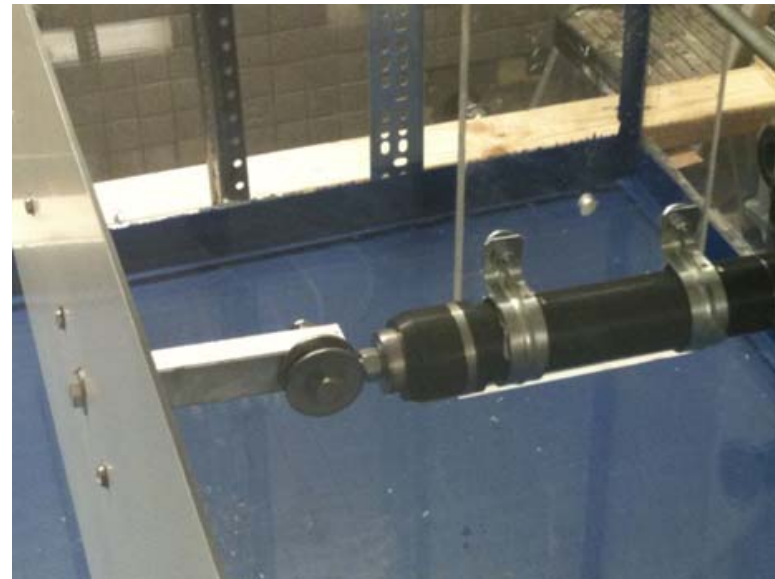

November-December



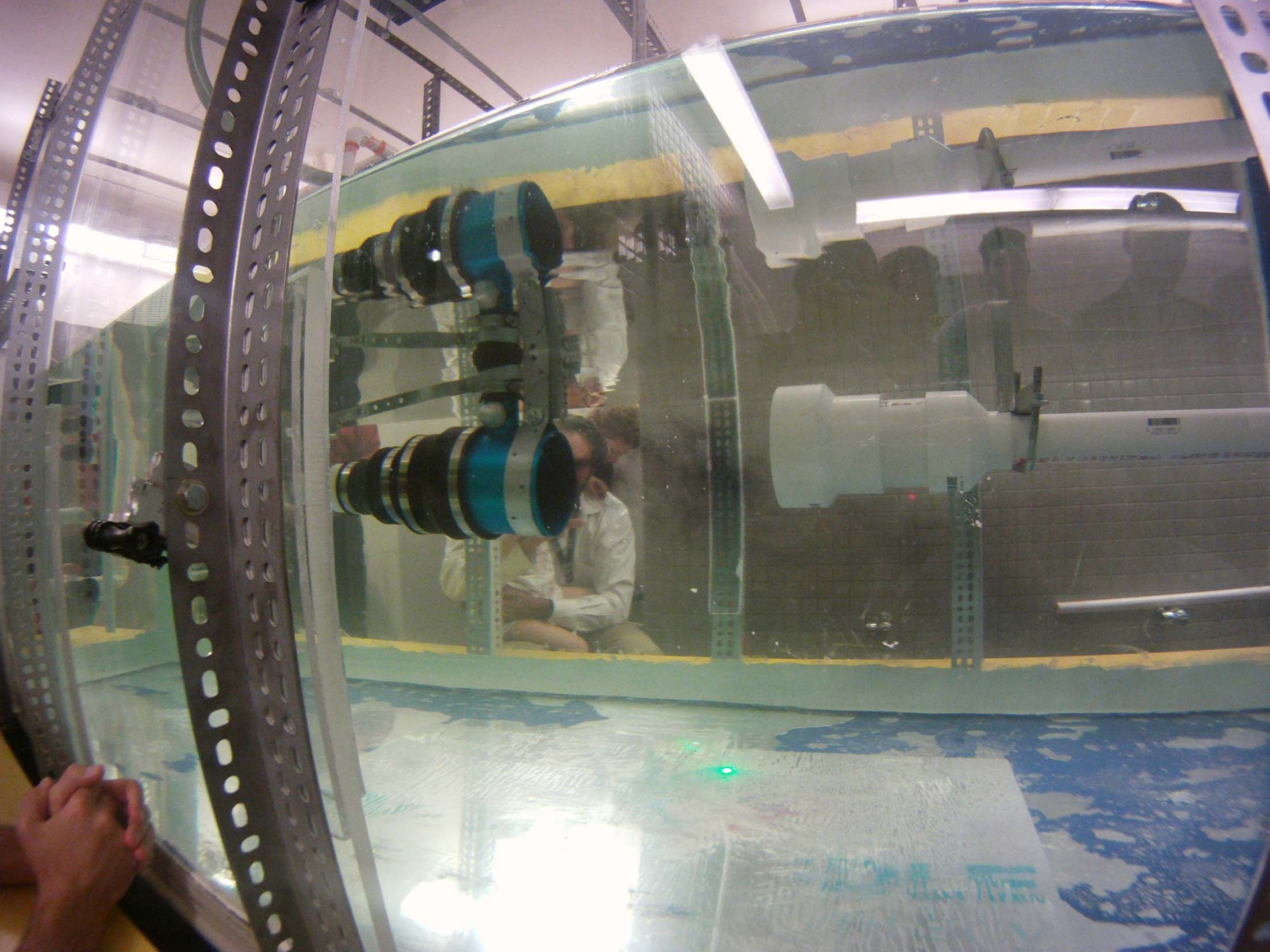

| Name               | Affiliation                  |   | Topic                                  | Currently is doing   |
|--------------------|------------------------------|---|--|--|
| Rebecca Woods      | CAPSTONE Spring 2012 (09/15) | <ul style="list-style-type: none"> <li>Reading Chap. 4</li> <li>Thinking at the laser beams problem</li> </ul>                                      | Theory for the NLWL experiments        | Solved the laser beams problem<br>Learned elements of Euler equation |
| Logan Dahle        |                              | <ul style="list-style-type: none"> <li>Study the actuator A24 experiment (Nov)</li> </ul>   | Experiments in NLWL,                   | Wrote a report on experiments on A24 from Nov.                       |
| Steven Z Thompson  |                              | <ul style="list-style-type: none"> <li>Designing a code for a hydrod. model (Sept.-Oct)</li> <li>Study the actuator A24 experiment (Nov)</li> </ul> | Experiments in NLWL, and Fortran codes | Wrote a report on experiments on A24 from Nov.                       |
| Brad Hansen        |                              | <ul style="list-style-type: none"> <li>Measured tank</li> <li>Helped constructions</li> </ul>   | Experiments NLWL                       | Made a tank model  |
| Nigel Smith        | Calc. 1                      | <ul style="list-style-type: none"> <li>Electric/electronic connections, various helps (11/20)</li> </ul>  |  | Main electric panel  |
| Amy N. Williams    | AE, senior                   | Acquired all data   | Design level control                   | Automatic controls and interfaces (10/05)                            |
| Marcus Jackson     | AE, senior                   |   | Design level control                   | Automatic controls and interfaces (10/05)                            |
| Ke You Teh         | EE, senior                   | Studied IR sensors and Parallax protoboards   | IR sensors and proto-boards            | IR sensors and proto-boards (10/10)                                  |
| Christopher Wright | Computer, sophomore          | Works on a general model of the lab automatics  | Design complete automatics             | Design complete automatics (11/16)                                   |
| Matthew Prescott   | Alumni math.                 | Helps hands on everything   | General help (10/10)                   |  |





## Research accomplished:

- Actuators law of motion (Dale, Thompson)
- Qualitative experiments 2+more fluids (JC)
- Teaching PDE with the water tank (FD+class)
- Automatics and lab modeling (Hansen, Williams, Jackson, Wright)
- Design and experiment laser reflection on water surface (RW)

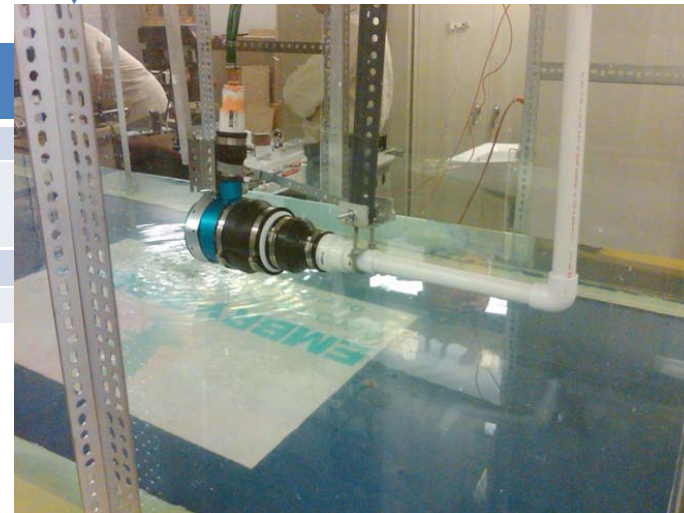
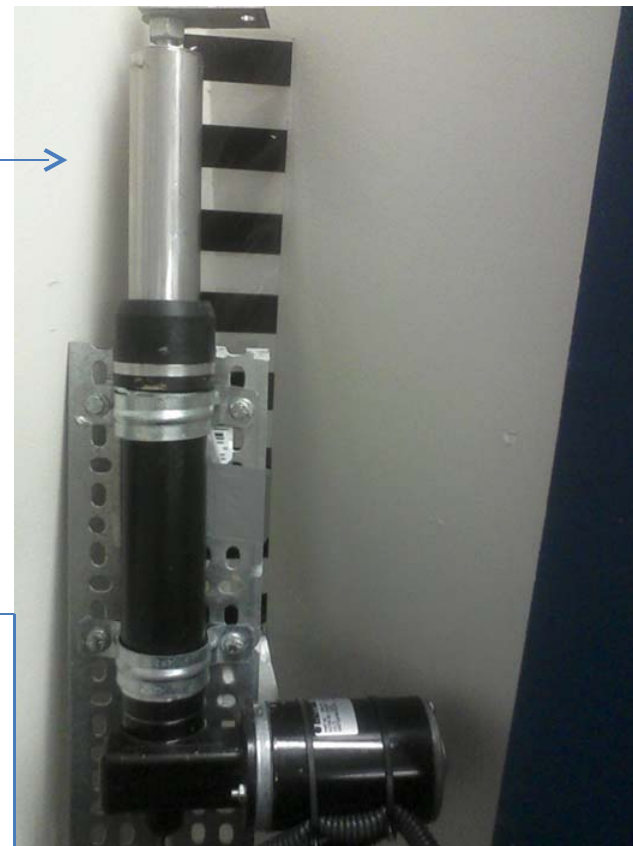

| Water height [m] | Paddle speed [m/s] | Wave speed [m/s] | Wave amplitude [m] |
|------------------|--------------------|------------------|--------------------|
| 0.130+-0.002     | 0.152+-0.001       | 0.63+-0.01       |                    |
|                  | 0.314+-0.001       | 1.21+-0.01       |                    |
| 0.187+-0.002     | 0.148+-0.001       | 1.34+-0.03       |                    |
|                  | 0.280+-0.001       | 1.49+-0.03       |                    |

- Experiments in medium height/shallow water at NLWL on 11/09/2011 with Dr. Drullion and her class.
- Experimental errors: Reaction time of observer, about 0.2 s. Distance 2%. Amplitude: 10%-20% depending on wave amplitude

- We have a fully operational wave tank
- Wave generators: 2 (electromagnetic actuators) out of 4 (stepper and pneumatic)
- Turbulence generator is operational
- Measurement of density and elevation with lasers: operational
- Data acquisition: oscilloscope and LabView: operational
- Trained students and working: 9
- Faculty actively involved: 2.5
- 1 lab technician (MP)
  
- TO DO
- Install stepper actuator for vortex generation
- Install compressed air actuator for earthquake simulation
- Install the interferometry fluid imaging
- Experiments splashdown for NASA
- Install the capacitive electric sensors for elevation
- Experiments with multiple fluid turbulence
- Experiments deep water solitons

UNIVERSITY OF ILLINOIS AT URBANA-CHAMPAIGN, Hydraulic Research lab:

- Turbidity
- Sediments
- Constructions
- Jets
- Bubbles



Texas A&M Engineering, Engineering Lab, Research Park,  
Offshore Research Technology Center



## Similar labs in the world



The University of North Carolina  
at Chapel Hill: Modular wave tank  
for multi-scale fluid dynamics  
(NSF funded, matched \$ .6-1 M):

- Jets
- Sediments
- Internal waves
- Solitons

Tel Aviv University, Water Waves  
Research laboratory:

- Nonlinear waves
- Random waves
- Tsunami



U. Maryland, Engineering,  
Fluid Dynamics Lab:

- Ship waves
- Wind wave tank

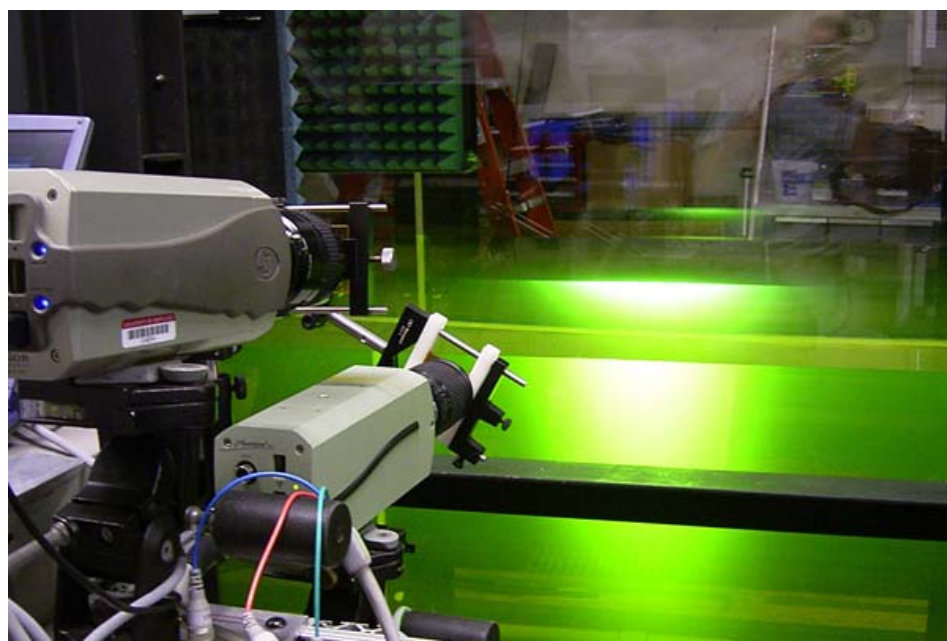

# NLWL 3

- 3,500 gallons water max.
- 32 feet long
- Multiple waves actuator
- PIV, LIF, Schlieren imaging, Interferometry
- Realistic earthquake simulator



# Experimental setup:

Pressure incoming water

Lasers: 3 visible red

Mixing observation chamber

"Fuel" line

Lasers: 2 visible blue, green and 1 I.R.

Zoom in "fuel" injection system: 2 pumps. Regimes: stepper, continuous or pulsed.

Electromagnetic gauges flow rate measurement

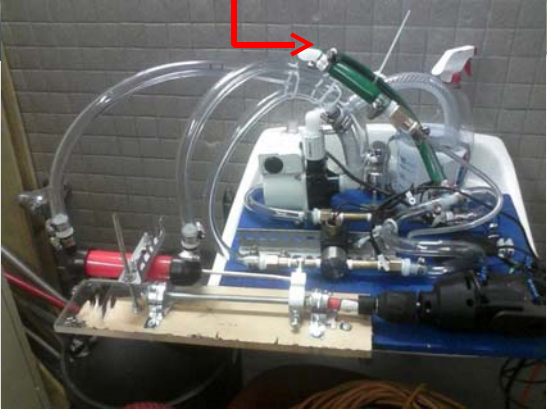
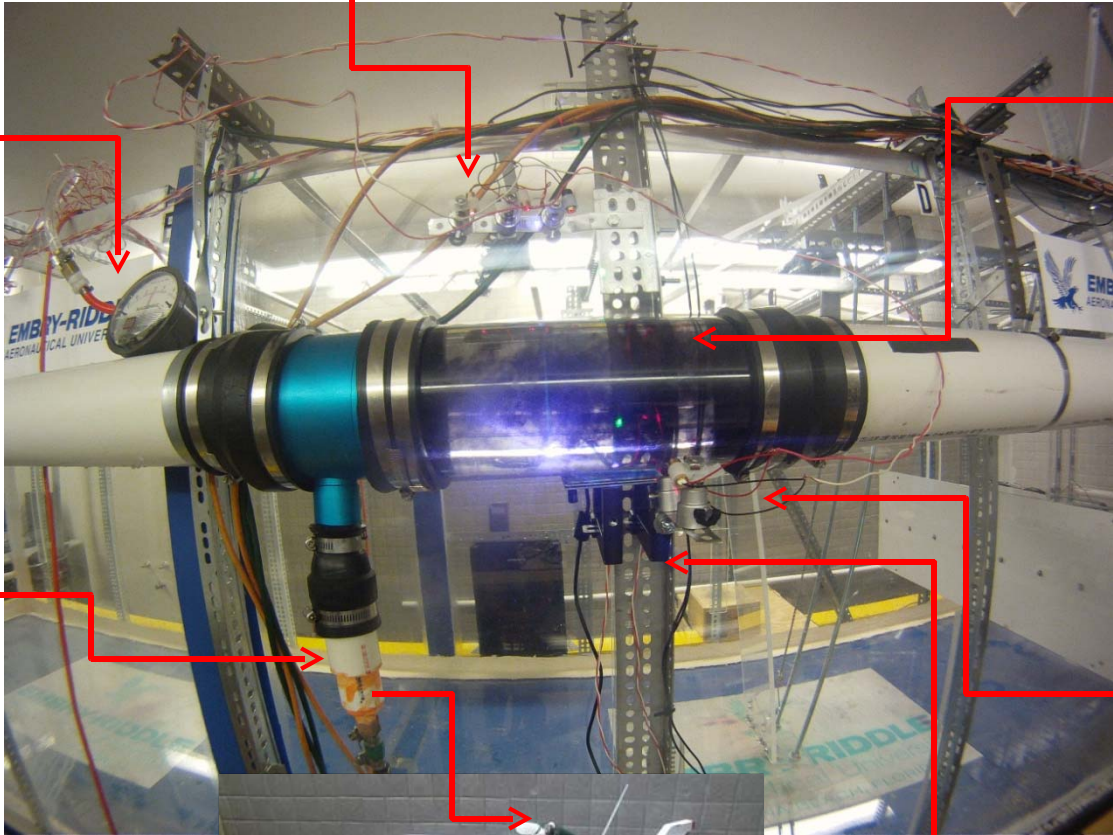

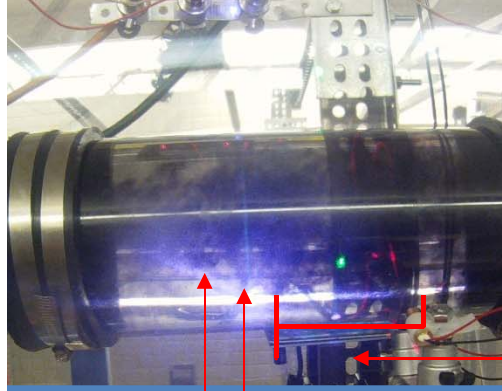

(1) Initial parabolic jet of "fuel"

(4) Translation and rotation of stable vortex patterns

(3) Formation of isolated vortices by interaction with walls

(2) Peeling of vortex sheets, von Karman streets

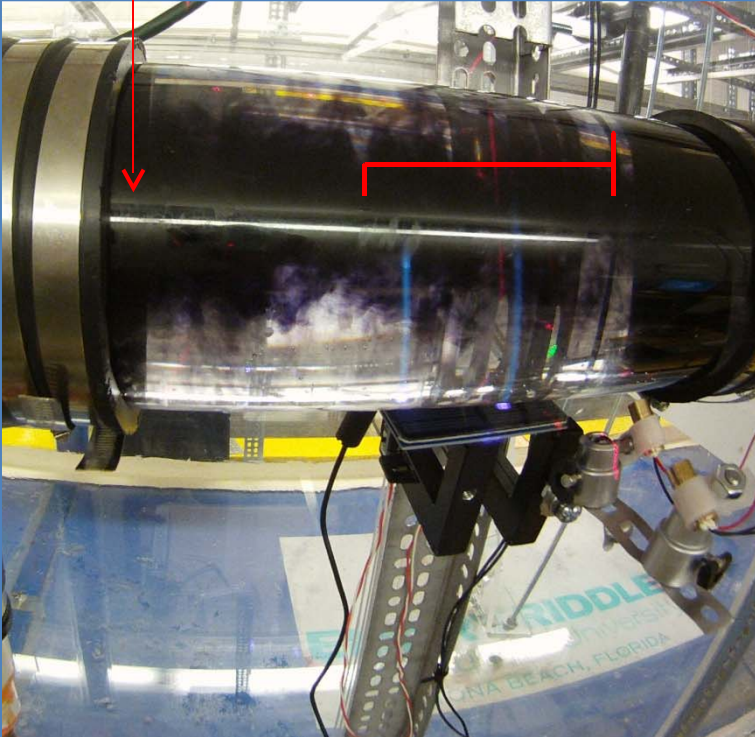

Experimental results for mixing studies with laser intensity signal. Without “fuel,” intensity in water is at normal max value. When “fuel” crosses a transverse laser beam intensity drops because of light attenuation. The amount of fuel-into-water integrated along that beam generates a proportional decrease in light intensity. By comparing the pattern, timing and amount of intensity drop in different laser beams at different orientations we obtain information of the quality of mixing.

Here below are results taken at 195 frames/s. One vortex is created at  $t=0.65$  s and persists 2 cm since the green laser does not record it anymore. Another vortex vanishes, since the yellow trace, which is further away from the disperser, receives a vortex before the first (blue) one.

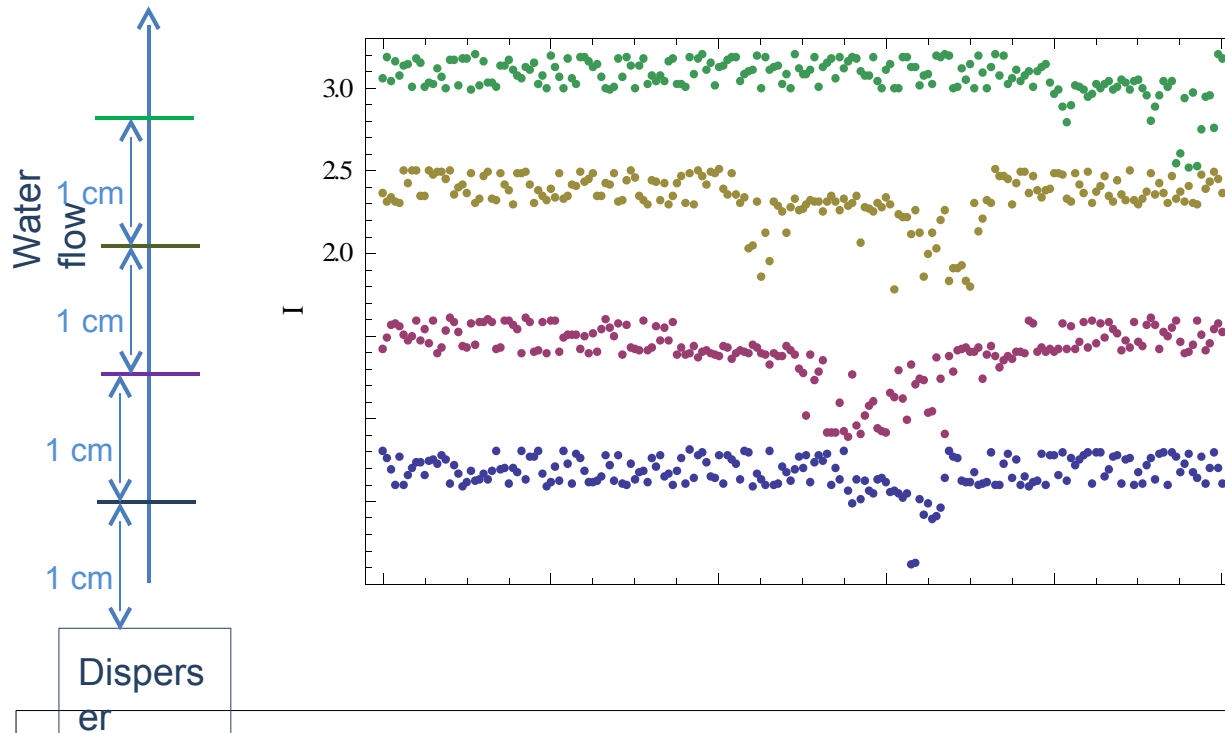

Relative laser transparency intensity vs. time in seconds. Four lasers all at 12-degree angle vs. z-axis, all at  $x=+2.5$  cm at 1 cm longitudinal x-separation.  
 Velocity water flow = .78 m/s      Pressure fuel = 31 cmH<sub>2</sub>O

Normalized laser transparency intensity ( $I$ ) versus normalized time ( $t$ )  
Four visible lasers. Same angle. 1cm longitudinal separation.  
 $V_0 = .15$  m/s     $PG = 32$  cm water

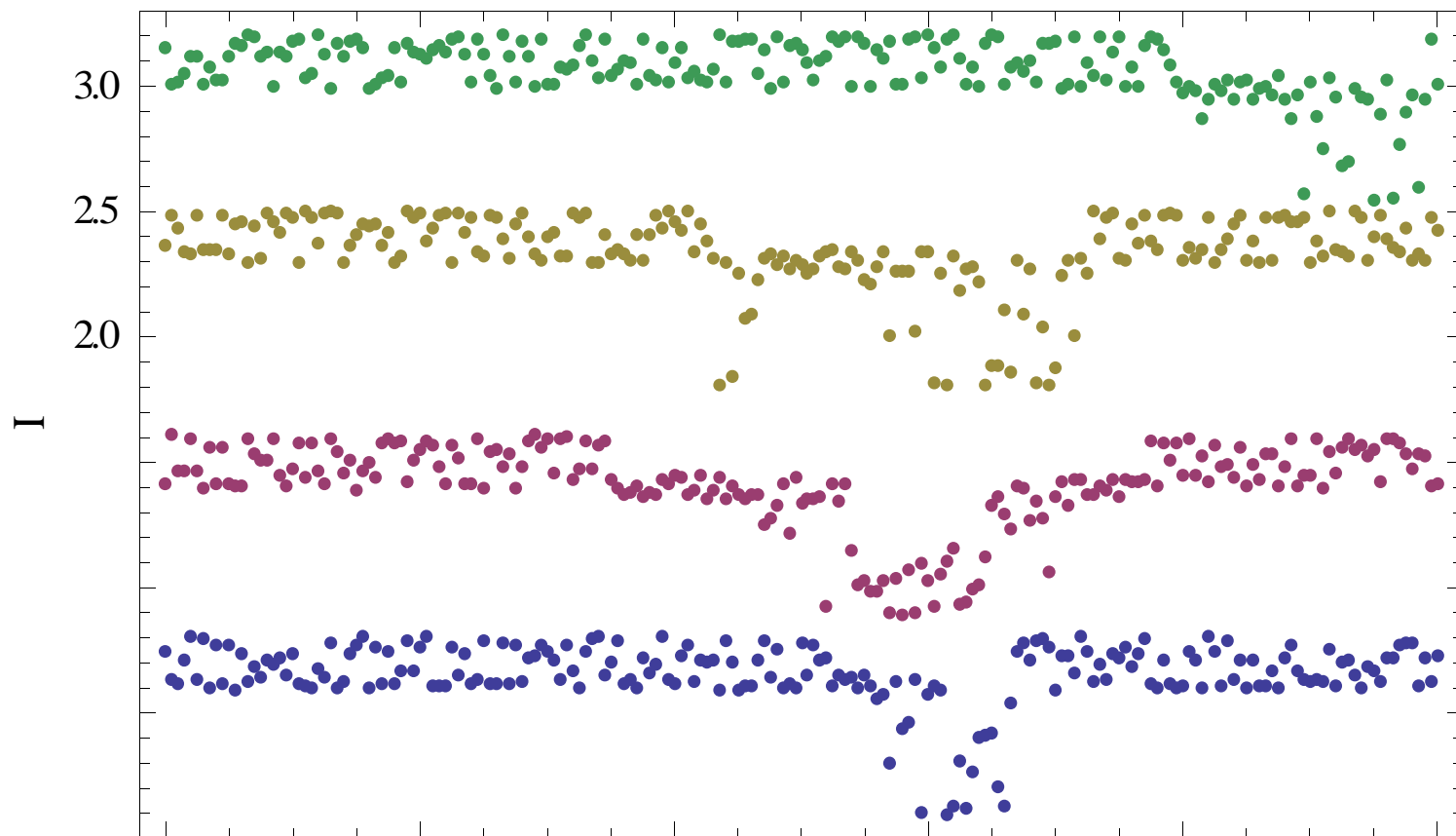

Lasers are placed at 90-degrees phase shift one from the other, and still at 1 cm along z separated. 195 fps.  
 A Von Karman vortex street (periodic structure of vortices) was detected. This vortex lattice (4 vortices) travels stable for about 3 cm. The last laser detects only the first vortex in the in the street: either the lattice dissipated, or it rotated around a diagonal axis as a combination of the interaction with the walls and the Strouhal instability.

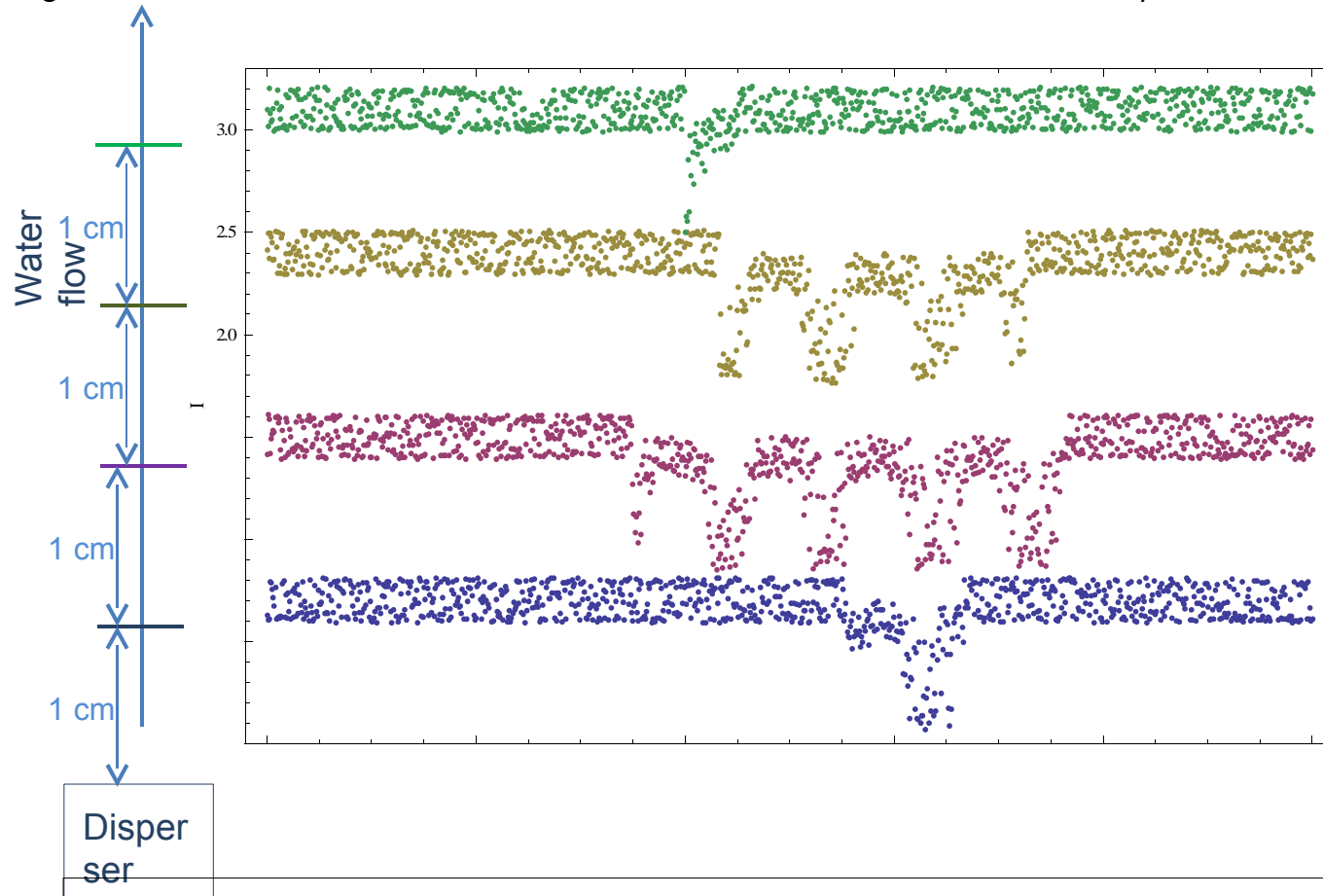

Relative laser transparency intensity vs. time in seconds.  
 Velocity water flow = 1.02 m/s    Pressure "fuel" = 26 cmH<sub>2</sub>O

Normalized laser transparency intensity (I) versus normalized time (t)  
Four visible lasers. Same angle. 1cm longitudinal separation.  
 $V_0 = .30 \text{ m/s}$  PG=28 cm water

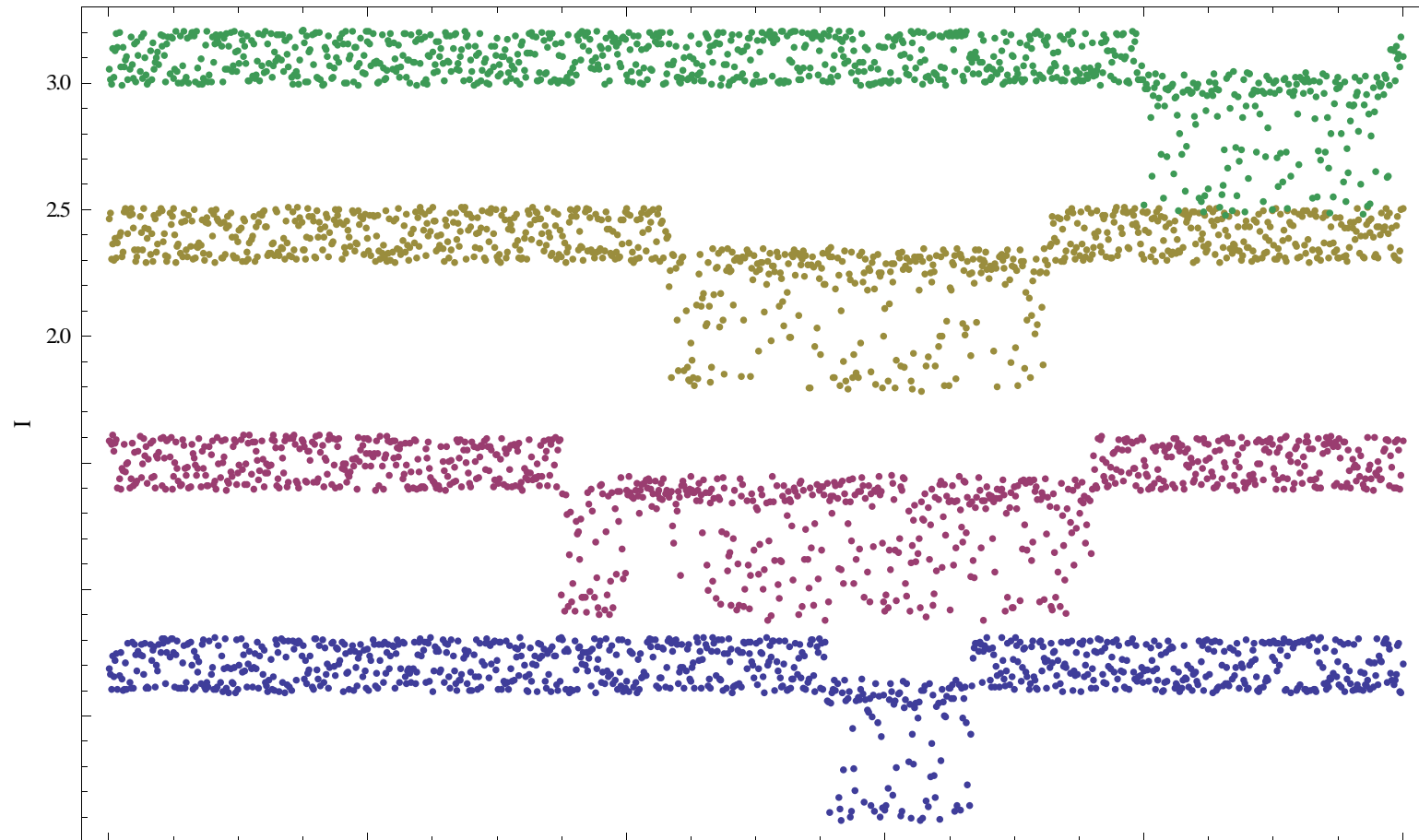

Normalized laser transparency intensity (I) versus normalized time (t)

Four visible lasers. Same angle. 1cm longitudinal separation.

$V_0 = 0.18$  m/s    PG=31 cm water

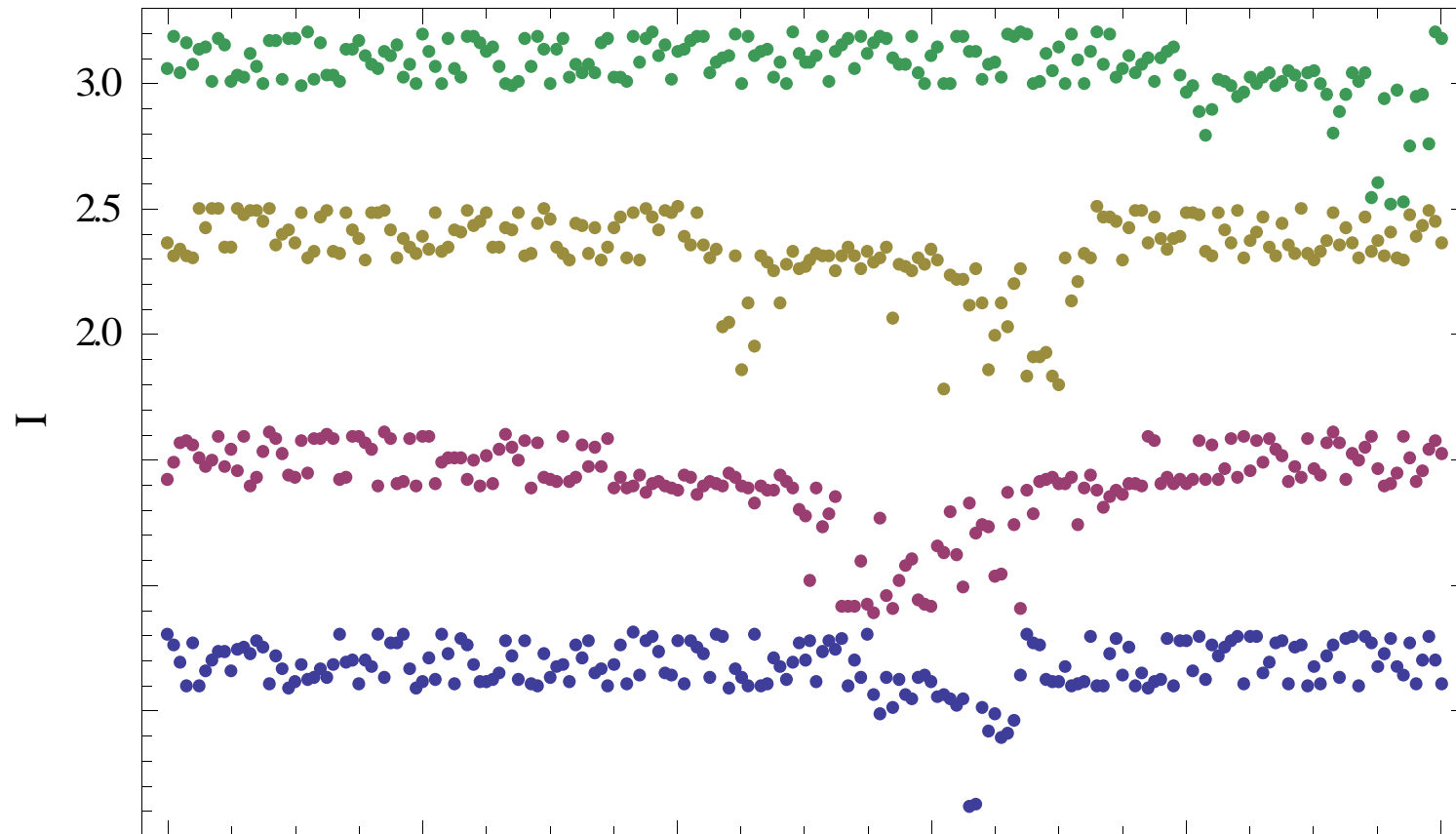

Computer processing of data: Wavelet interpolation (D5)

V0=.80 m/s PF=29 cmw

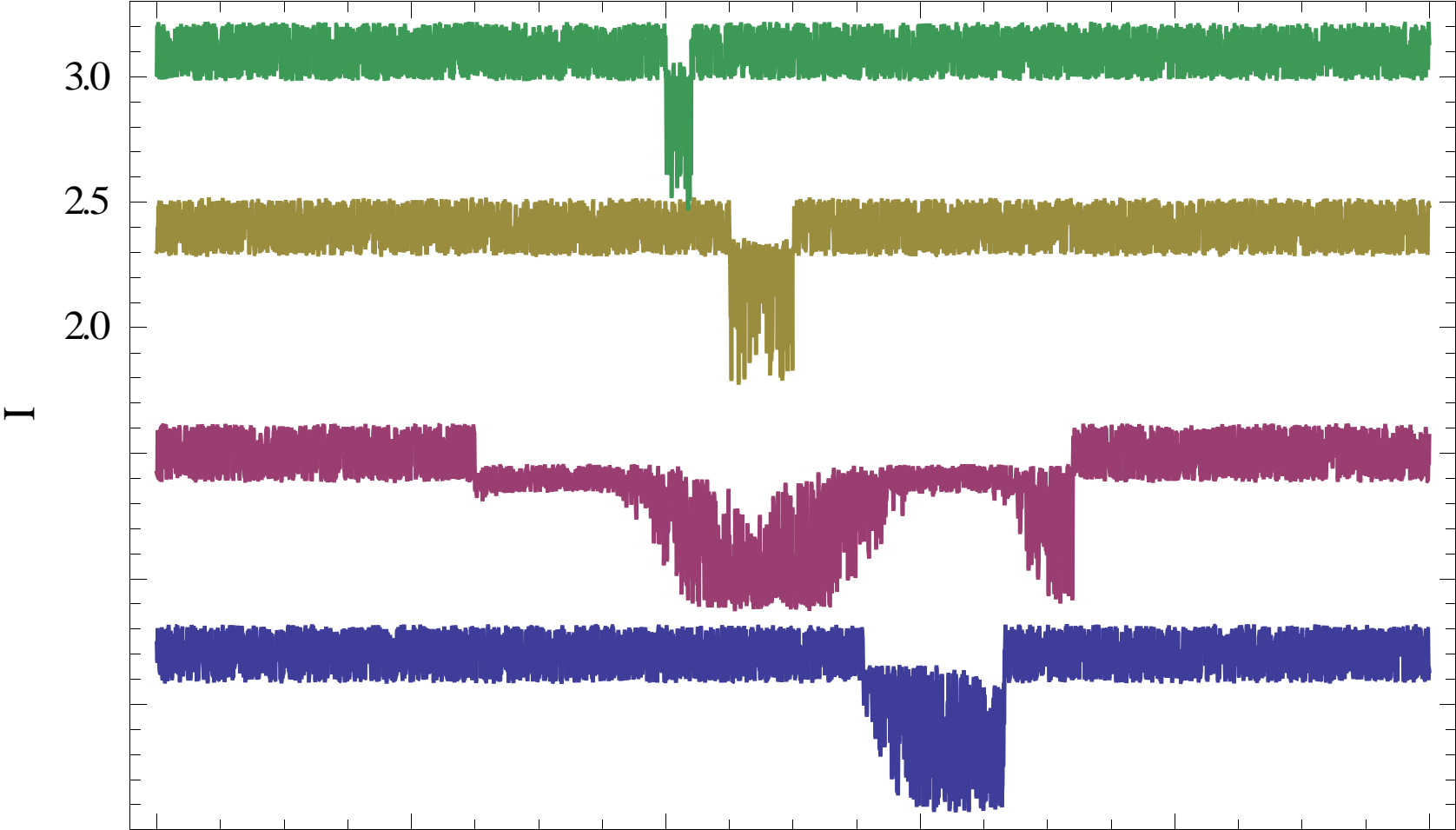



Wavelet interpolation (D5)  
V0=.19 m/s PG=29 cm water

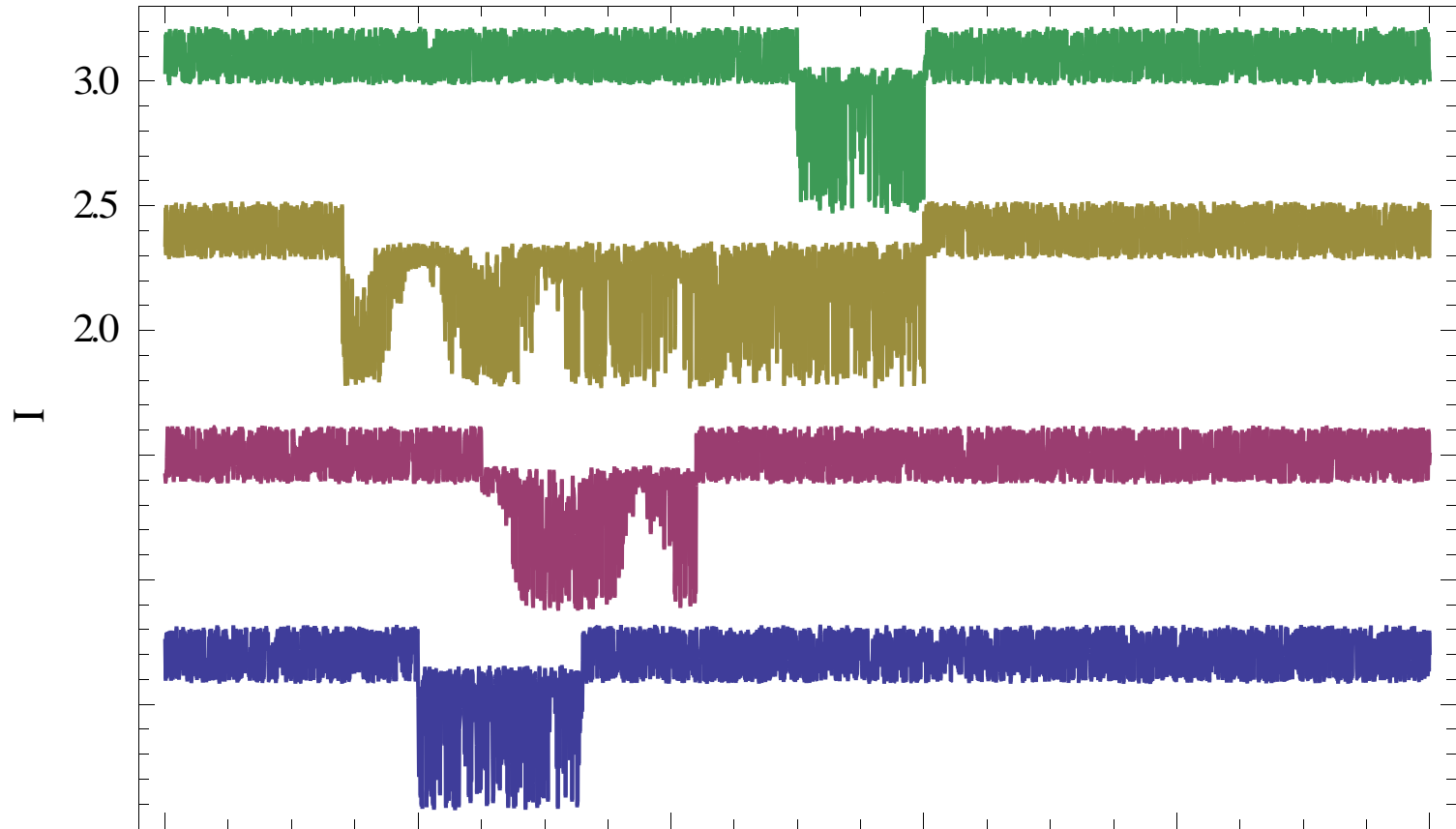

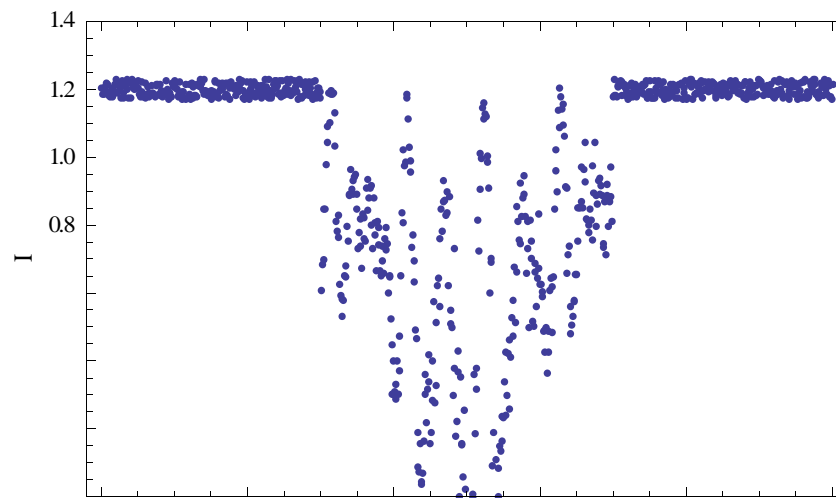
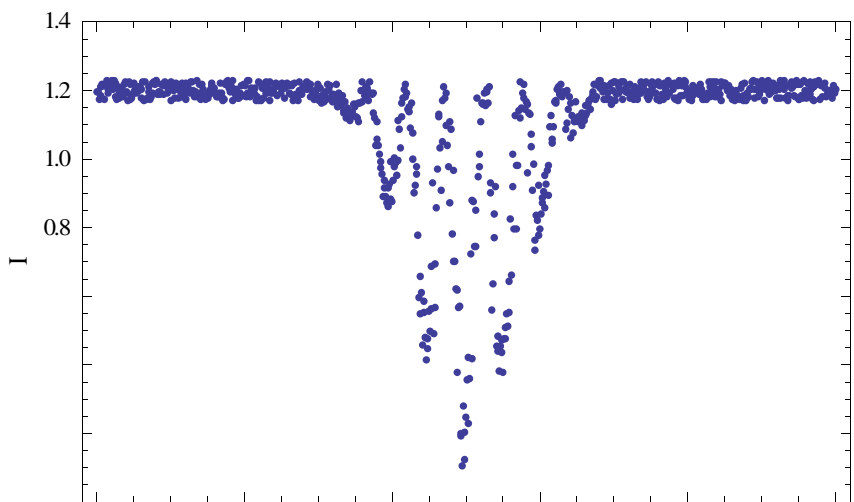
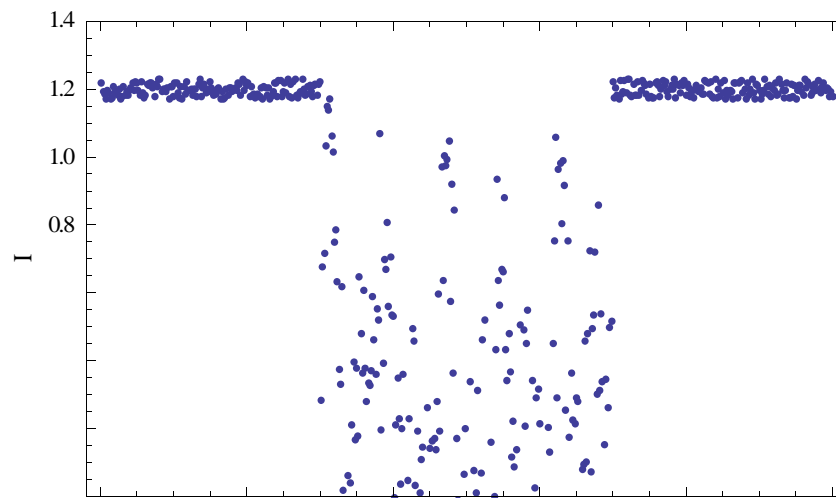
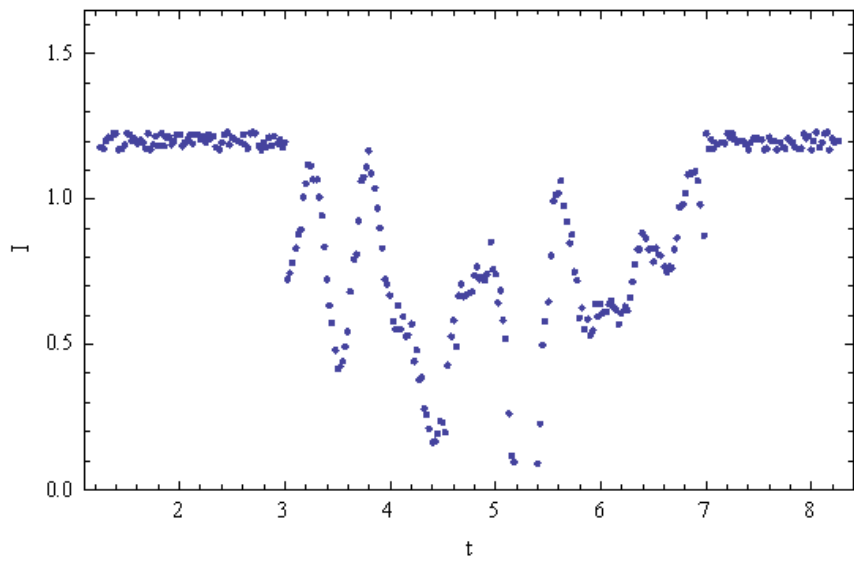

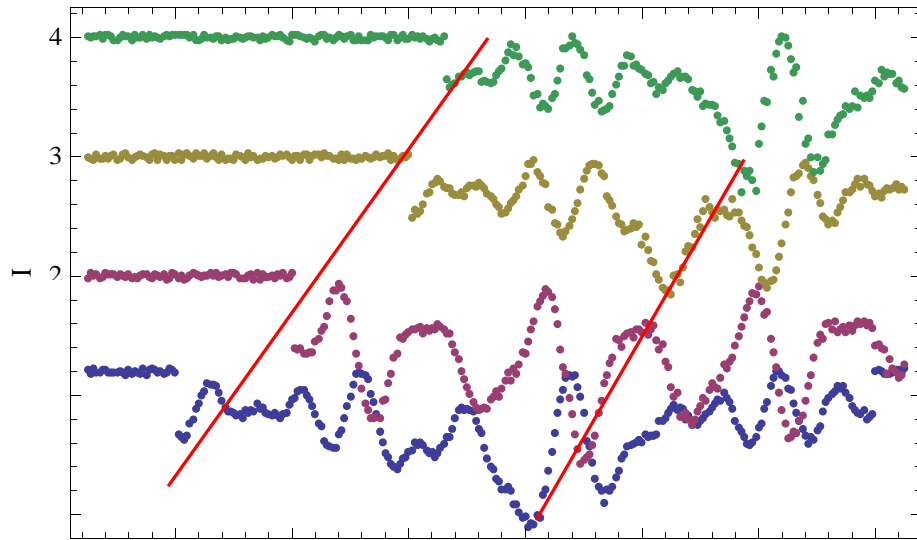

- Time (space) evolution of one vortex pattern.
- Winding number 6-7 decreases in time, instead of increasing
- Stability in time of patterns can be measured

- Rotational distribution of one vortex pattern.
- It shows coherence and finite volume.
- Sizes can be measured

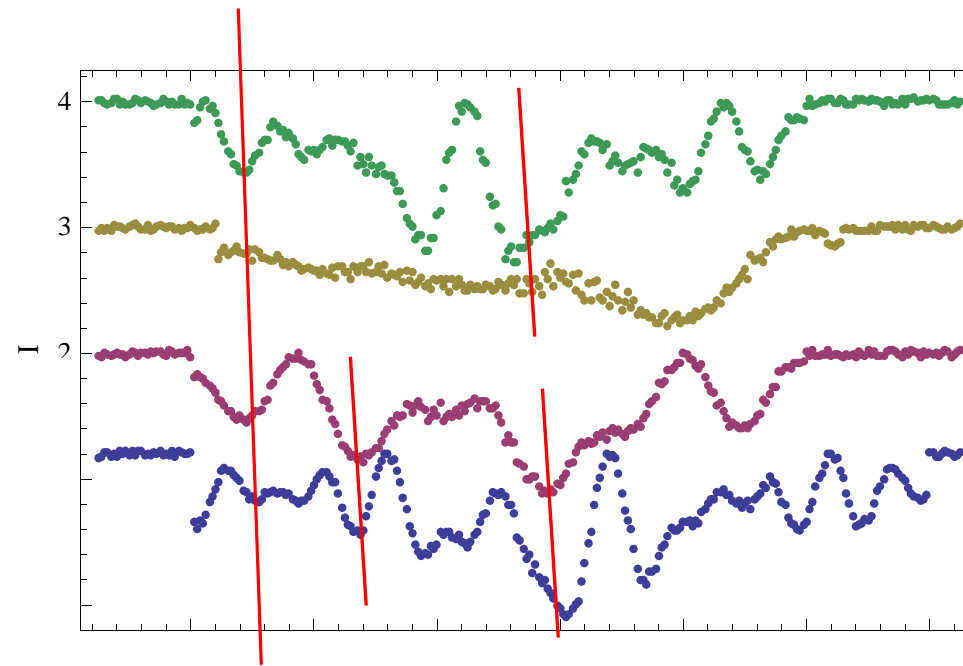

## CONCLUSIONS

We presented enhancement of diffusive mixing on a compact Riemannian manifold by a fast incompressible flow.

We described the class of flows that make the deviation of the solution from its average arbitrarily small in an arbitrarily short time, provided that the flow amplitude is large enough.

The necessary and sufficient condition on such flows is expressed naturally in terms of the spectral properties of the dynamical system associated with the flow.

Further studies are needed for non-compact manifolds, or compact manifolds with Dirichlet BC. The optimal shape of the fixed obstacles in the mixing device could be obtained through such a research.

June 18-22, 2013

# Conference on Nonlinear Systems and Summer School, Kathmandu, Nepal (2013)

कन्फेरेन्स अन ननलिनियर सिस्टम्स एण्ड समर स्कूल, काठमाडौं, नेपाल (२०१३)

## Contents

- Welcome ▶
- Important Dates ▶
- Scientific Committee ▶
- Plenary Speakers ▶
- Special Sessions ▶
- Abstracts ▶
- Conference Venue ▶
- Scientific Program ▶
- Summer School ▶
- Travel Information ▶
- Proceedings ▶
- Registration ▶

CNLS-2013

HOME ABOUT US CONTACT

## General Information

The study of Nonlinear Systems has emerged as a major area of interdisciplinary research. In recent years, significant advancement has been made in many areas of applied mathematics related to Nonlinear Systems, including applications of mathematical modelling, computations and analysis. The conference on Nonlinear Systems (CNLS) is intended to provide a widely selected forum among scientists to exchange ideas, methods, and techniques in the fields of Nonlinear Systems and their applications in physics, chemistry, biology, economics and engineering. Interdisciplinary aspects of the subject will be emphasized, as well as the interaction between computation, theory and applications. Participants from many countries are invited with a wide range of plenary talk topics and many interesting special sessions consisting of regular presentations. Volunteers to organize special sessions are now being requested. Interested persons please [contact](#) the organizers.

CNLS (June 18 - June 22, 2013) succeeds the [Nonlinear waves, theory and applications](#) conference in Beijing, China.

During the three weeks of Summer School (May 27 - June 14, 2013) we aim to give participants an idea of advanced mathematical and computational methods in nonlinear (systems) of (partial) differential equations, as well as some current research areas where these methods are being further developed and applied. The detail programs of the summer school can be found [here](#).

The conference in Nonlinear Systems and summer school, Kathmandu, Nepal (CNLS-2013) is hosted by the Central Department of Mathematics, Tribhuvan University Nepal.

